



Pumps

Cast Iron Jet

Stainless Steel Jet-Inox

Composite Jet-Com



1. Introduction

Congratulations on your purchase of a dependable DAB jet pump.

This manual covers the range of single impeller Jet type (cast iron) Jet-Inox (stainless steel) and Jet-Com (Composite) pumps:

- **Cast Iron Jet:**
Robust cast Iron housing with reinforced composite internals
- **Stainless steel Jet-Inox:**
Corrosion resistant stainless steel housing with reinforced composite internals
- **Composite Jet-Com:**
Corrosion free composite housing with reinforced composite internals

'Self priming' jet type pumps incorporate an internal venturi enabling water to be drawn from below ground level. Your pump is equally comfortable pumping from a tank, boosting low pressure water supply or working in conjunction with a rainwater changeover device.

There are a five pump motor sizes in the 3 ranges. You can purchase a bare pump or White International offer a number of pump control options to give the end-user maximum flexibility to select the system best suited to their application.

With the aim of getting you up and running quickly, most of the controller options are available pre-wired which don't require a licensed electrician to install.





2. Key Features

- Self Priming to 9 metres at sea level
- Designed specifically for rainwater tanks, shallow well, spear and bore holes to a maximum depth of 9 metres. Ideal for long suction lines
- **Wear Rings:** Stainless Steel
- **Mechanical Seal:** Carbon / Ceramic
- **Seal Disc:** Stainless Steel
- **Motor Support:** Die-Cast Aluminium
- **Motor shaft:** 304 Stainless Steel
- **Impeller, Diffuser, Jet / Venturi:** Technopolymer
- AS/NZS 4020 Approved for Drinking Water









3. Contents

1. Introduction	2
2. Key Features.....	2
3. Contents.....	3
4. ISO 7010 Symbols used in this manual.....	3
5. Warnings	4
5.1 Cautions	5
6. Standards and Approvals.....	5
7. Technical Specifications	6
8. Electrical Connections.....	7
9. General installation notes.....	8
10. General intake (suction) piping notes	9
11. Boosting mains supply or connecting to a hot water system.....	10
12. Pressure Tank recommendations.....	10
13. Water supply above the pump inlet (flooded suction)	11
14. Water supply below the pump inlet (suction lift)	12
15. Priming and Operation.....	13
16. Warranties – Terms and Conditions.....	14
17. Trouble Shooting Guide.....	15

4. ISO 7010 Symbols used in this manual

	Warning - Electrical safety
	Warning – Potential consequences of use outside of intended application(s). Includes environmental condition warnings.
	Mandatory warning
	Warning to disconnect power
	Read carefully



5. Warnings

	Read the manual carefully before starting and retain for future reference.
	Prior to starting installation or any maintenance the pump must be disconnected from the power supply and pressure relieved from the system including controller, pump and associated pipework.
	Any changes or modification to the wiring must be carried out by suitably qualified personnel.
	A qualified electrician should correctly size and install circuit breakers to protect the power supply. The fitment of additional surge protection is recommended.
	Never open the controller cover or pump terminal box cover while controller is connected to electrical supply.
	This appliance is not intended for use by persons (including children) with reduced physical, sensory or mental capabilities, or lack of experience and knowledge, unless they have been given supervision or instruction concerning use of the appliance by a person responsible for their safety. Children should be supervised to ensure that they do not play with the appliance.
	To avoid excessive thermal shock to the motor the pump should not start more than 30 times in any one hour period.
	Ensure that the installation will comply with all applicable local regulations.

5.1 Cautions

- 5.1.1 Protect the pump and controller from rain and moisture and minimise exposure to extremes of heat and cold. Operating range 3°C - 40°C.
- 5.1.2 The pump is designed for use with clean water. Contamination including sand or mineral deposits may affect the operation of the pump and controller.
- 5.1.3 The pH of the water must be between 6.5 and 8.5.
- 5.1.4 This pump is not suitable for use with spa or pool water.
- 5.1.5 Running the pump without water or allowing the pump to run dry will damage the mechanical seal and void the warranty.
- 5.1.6 Avoid situations where the pump could be exposed to corrosive liquids or gasses, or to flammable materials, solvents etc.
- 5.1.7 Fitment and replacement must be carried out by competent, skilled and qualified personnel.

6. Standards and Approvals

	<p>SAA Approvals is accredited by the Joint Accreditation Service of Australia and New Zealand (JAS-ANZ) as a third party certification body to issue of Certificates of Approval for declared and non-declared electrical equipment that has proven to comply with the safety requirements of the applicable Australian Standard.</p>
	<p>Pumps that carry the AS/NZ4020 Drinking Water Approval demonstrate compliance with requirements of Australia & New Zealand Standards of products that come into contact with water intended for human consumption. This approval also ensures that the water coming from the pump will not be contaminated by toxic materials or metals. It also means the water will not support the growth of micro-organisms and will not cause a change in taste or appearance.</p>
	<p>CE marking is a certification mark that indicates conformity with health, safety and environment. The CE marketing represents a manufacturer's declaration that products comply with the EU's New Approach Directives. These directives not only apply to products within the EU but also for products that are manufactured in or designed to be sold in the EEA.</p>

7. Technical Specifications

SPECIFICATIONS

Cast Iron	Jet62M	Jet82M	Jet102M	~	Jet132M
Stainless Steel	JetInox62M	JetInox82M	JetInox102M	JetInox112M	JetInox132M
Composite	JetCom62M	JetCom82M	JetCom102M	~	JetCom132M
Maximum head	41.9m	46.9m	53.7m	60.9m	47.9m
Maximum flow	45 lpm	60 lpm	60 lpm	58 lpm	82 lpm
Pump Start	Controller Dependant				
Pump Stop					
Input power	220 (-6%) - 240V (+6%) 1ph 50Hz				
Motor	Asynchronous TEFC motor with in-built auto reset thermal overload				
IP Rating / Insulation	Ingress Protection - IPX4 / F Class Motor Insulation				
Motor Rating (KW)	0.44kW	0.6kW	0.75kW	1.0kW	1.0kW
HP	0.6hp	0.8hp	1.0hp	1.36hp	1.36hp
Max Amperage	3.12 amps	3.8 amps	5.1 amps	6.2 amps	6.6 amps
Start Capacitor	13 uF	13 uF	16 uF	25 uF	25 uF
Pump materials	Pump body: Jet = Cast Iron, JetInox = Stainless Steel 304, JetCom = Composite Jet/Venturi, Diffuser, Impeller: Technopolymer Glass Reinforced Composite O Rings: Nitrile				
Mechanical Seal	Carbon/Ceramic/Nitrile				
Inlet/Outlet Size	Suction 1" BSPF / Discharge 1" BSPF (Bare pump)				
Pressure Tank	2 - 18 litre recommended for most efficient operation				
Maximum pressure	Cast Iron Jet and Composite JetCom = 6 bar Stainless steel JetInox = 8 bar				
Working temp range	2 - 40°C				
Power Cable	2m long 10 amp rated H05 flex with AS/NZ 3112 (Type I) 3 pin male power plug				

8. Electrical Connections

Always use an electrical outlet that is protected by Residual Current Device (RCD) Safety Switch with a trip current of 30mA or less. A Safety switch is required by Australian/New Zealand Standard AU/NZS 60335.1-2011.



The pump is supplied with a 10 amp rated lead and AS/NZ 3112 (Type I) 3 pin male power plug for connecting to mains power.

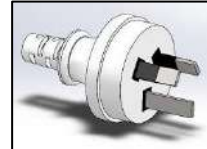

Exercise care with the power cord. Route the cord carefully to avoid potential snagging or chafing hazards. Never lift the pump by the power cord or disconnect from the power supply by pulling the cord.

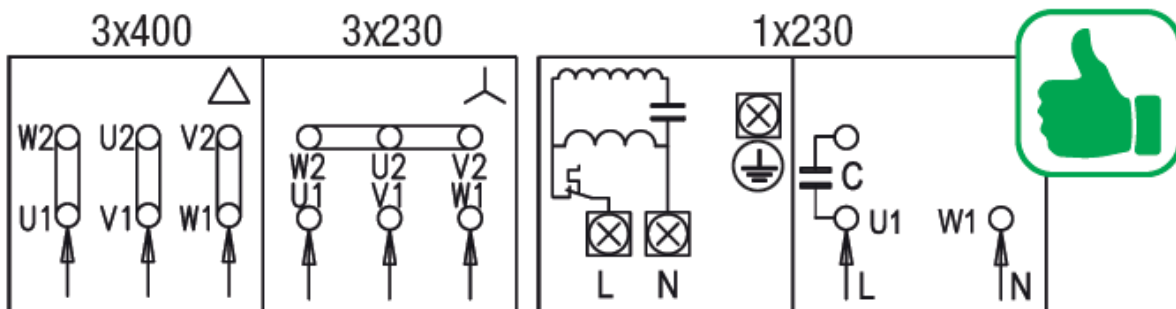

White International offer a number of pump control options to give the end-user maximum flexibility to select the system best suited to their application.

Consult the instruction manual supplied with the controller selected for any additional information.



“Simple and efficient solutions are the biggest types of innovations. The technology of our products speaks the same language of those who buy or use them. This is our strength.”

Sandro Stramare
DAB Group CEO

9. General installation notes



Review Section 5 - Warnings and 5.1 - Cautions prior to installing

Choose a pump location with a firm base as close to your water source as possible and close to a suitable power supply.



Avoid extension cords. If an extension cord must be used ensure it is correctly rated.

The pump should be housed in a weather proof, free draining, well vented enclosure to protect it from the extremes of temperature, moisture, flooding, chemicals, vermin and insects, dust etc.



Before installation, inspect the pump for any shipping damage.

If solid fittings are used to connect to the pump ensure the pump is mounted securely on a concrete tile, concrete base or similar. If the pump is not mounted securely then flexible piping connectors are recommended.



Avoid strain on the pump casing by supporting your pipework.

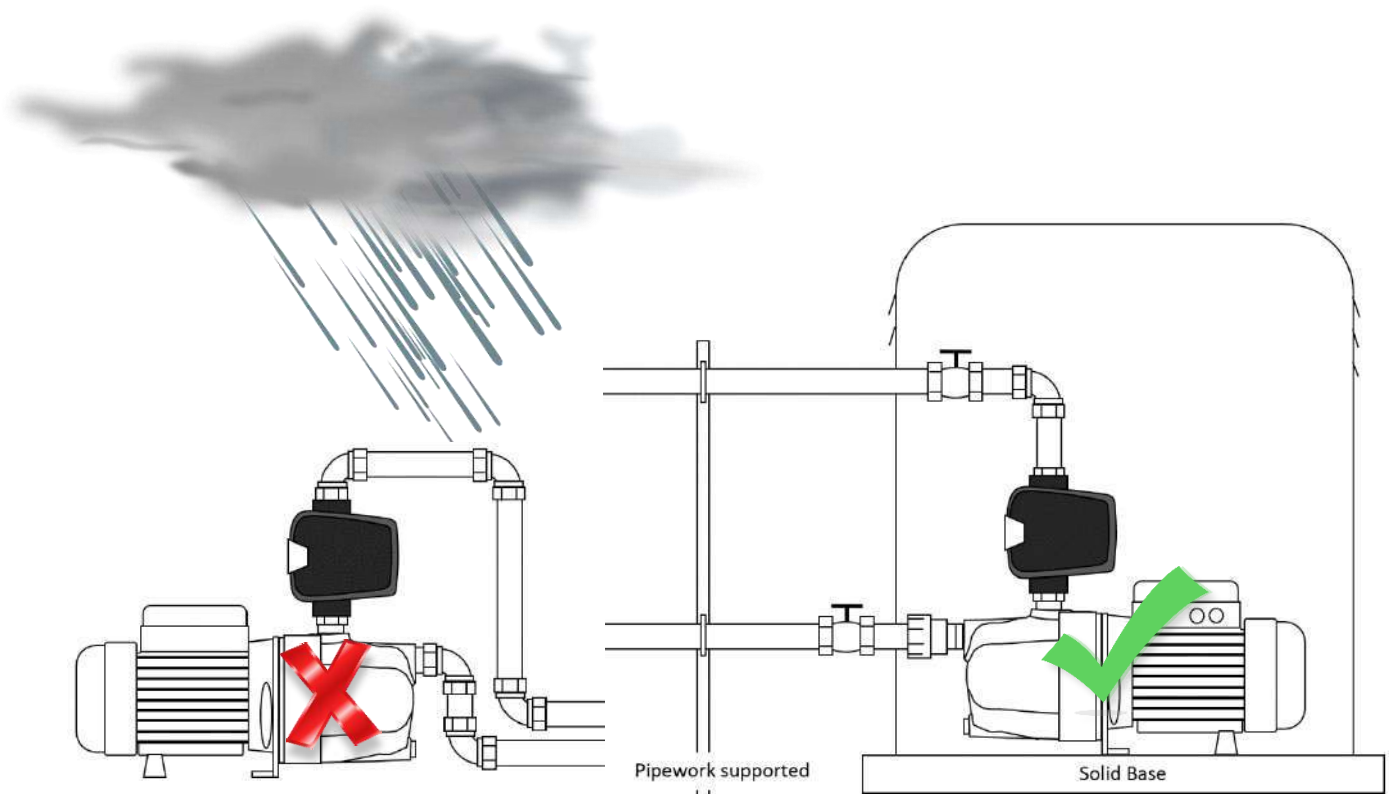

10. General intake (suction) piping notes

The intake suction piping is the most critical part of the installation. Errors or air leaks will cause significant issues for performance and pump reliability.



Reminders of best practice:

Pipe size must be equal to or larger than the inlet port size (see Section 14)

Inlet piping as short and straight as practical

Avoid bends within 150mm of the inlet port

Avoid pipework which results in air pockets

Connection to the pump using unions ensures easy removal for servicing

If the water supply is above the pump inlet, fit an isolating valve close to the pump

A gate valve on the pump discharge will aid diagnosing system problems

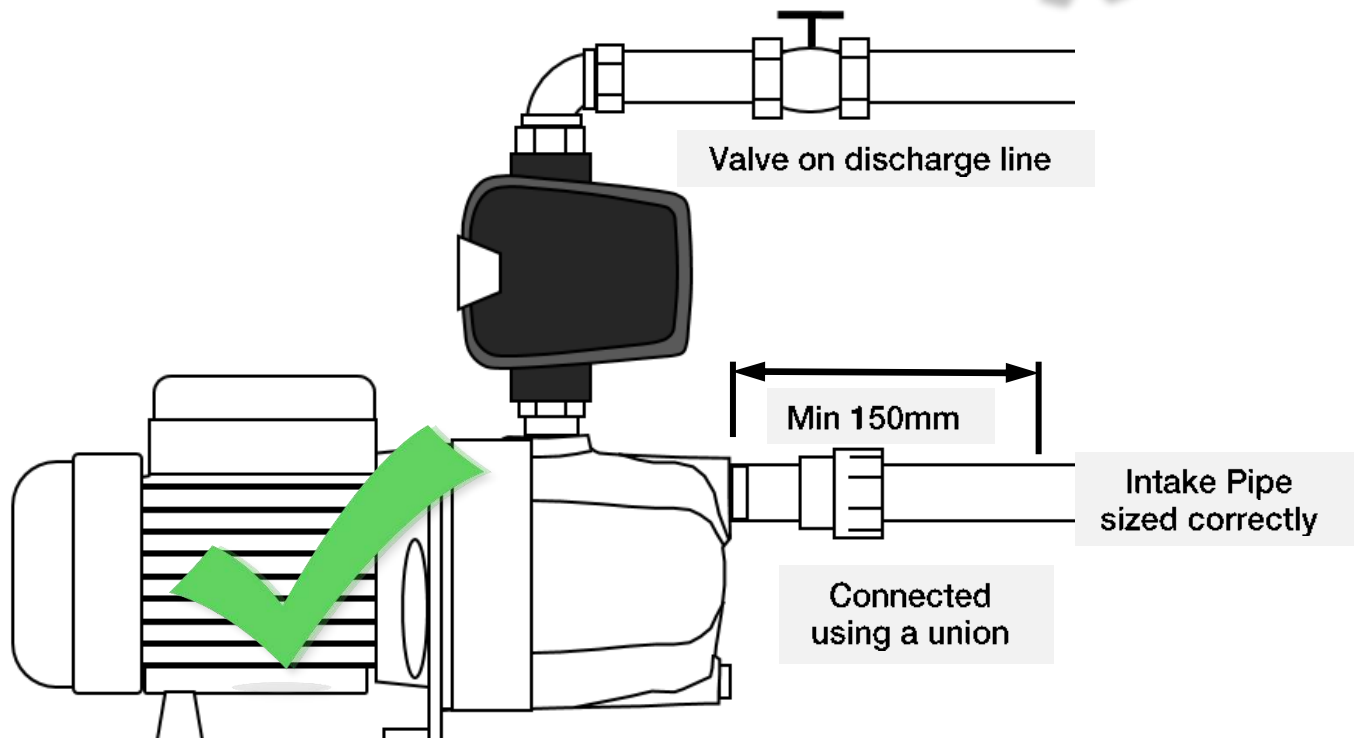
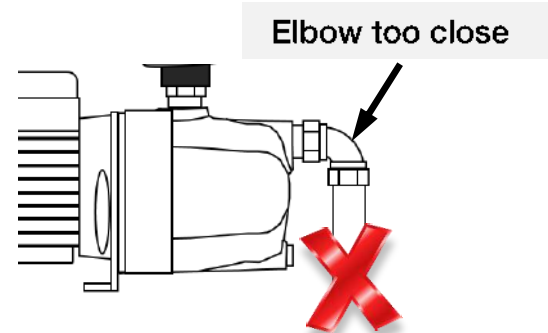
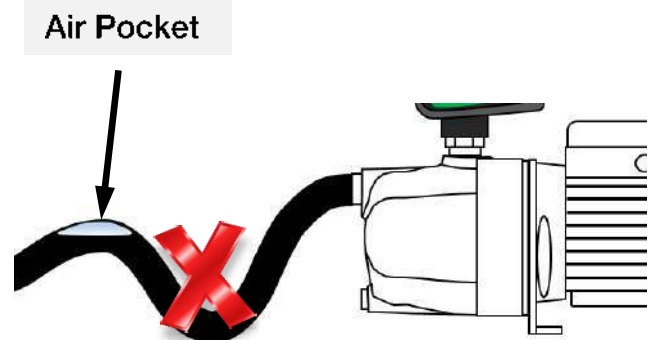

Optional: If the water is known to contain particles (sand etc.) an in-line strainer/filter can be fitted. Usually 500 micron is sufficient, Regular maintenance is required to keep an in-line strainer/filter clean and ensure best pump performance.

11. Boosting mains supply or connecting to a hot water system

Boosting Mains supply

Connecting directly to mains water supply is not recommended.

If mains pressure is poor, best practice is to install an isolating (break) tank.

Use the guidelines in Section 13 or 14 depending whether the water supply will be above or below the pump inlet.



Pumps supplying Mains Pressure Hot Water Systems:

An approved Non Return Valve should be fitted to the hot water inlet to protect the pump from backpressure due to expansion.

Pumps supplying Low Pressure Hot Water Systems:

Fit a pressure reducing valve to ensure pump maximum pressure doesn't exceed hot water cylinder rating.

Hot water systems must be installed in accordance with the manufacturer's recommendations and comply with all local regulations.



12. Pressure Tank recommendations

Fitting a pressure tank is highly recommended in every case. It will reduce the number of times the pump starts, saving energy and prolonging the life of the pump.

If the pump is fitted with a pressure controller (pump starts when pressure falls, stops when flow is less than 1lpm) then a 2 – 18 litre tank gives best results.

If the pump is fitted with a pressure switch (pump starts when pressure falls, stops when pressure rises) then a tank size should be selected to ensure the pump starts less than 30 times per hour. For most domestic situations an 18 litre tank is sufficient.

- ✓ Note: some electronic pressure control models are able to act as a pressure switch

Water column above controller

Cut in Pressure	Maximum static head
1.0 bar	Less than 5m
2.0 bar	Less than 15m
3.0 bar	Less than 25m
4.0 bar	Less than 35m
5.0 bar	Less than 45m
6.0 bar	Less than 55m



The column of water above the controller cannot exceed the equivalent pump start pressure.

If necessary, the controller can be raised.



NO water can be drawn off between the pump outlet and the control unit.

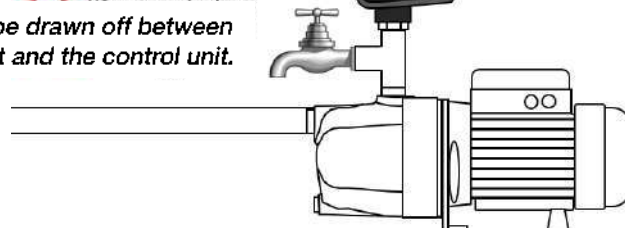

13. Water supply above the pump inlet (flooded suction)



Review SECTION 6 and 6.1 (Warnings and Cautions) prior to installing

Reminders of best practice

- ✓ Fit a valve to isolate the tank
- ✓ If the suction line is quite long, fit another valve close by the pump
- ✓ A non-return valve in suction line is recommended
- ✓ Avoid pipework which could trap air

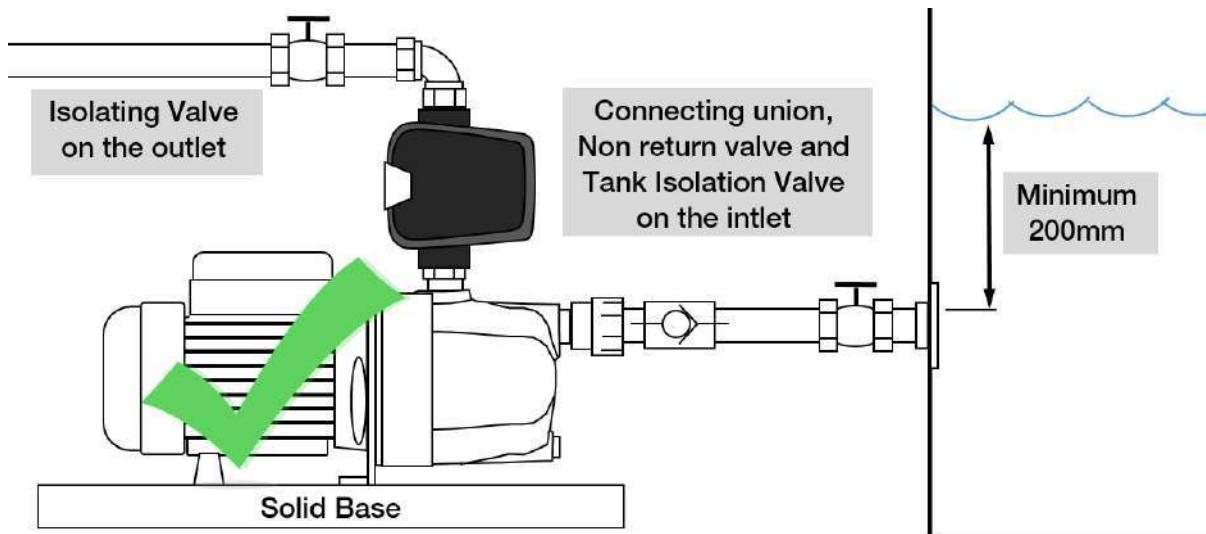

In this example the water level is higher than the pump inlet but the water cannot flow freely into the pump.

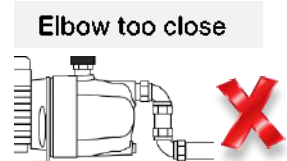
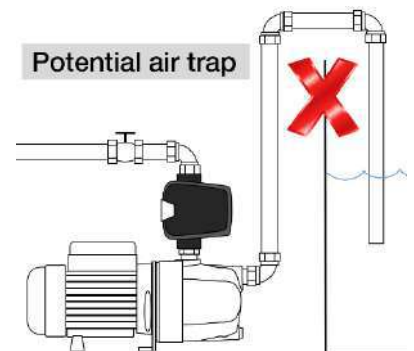
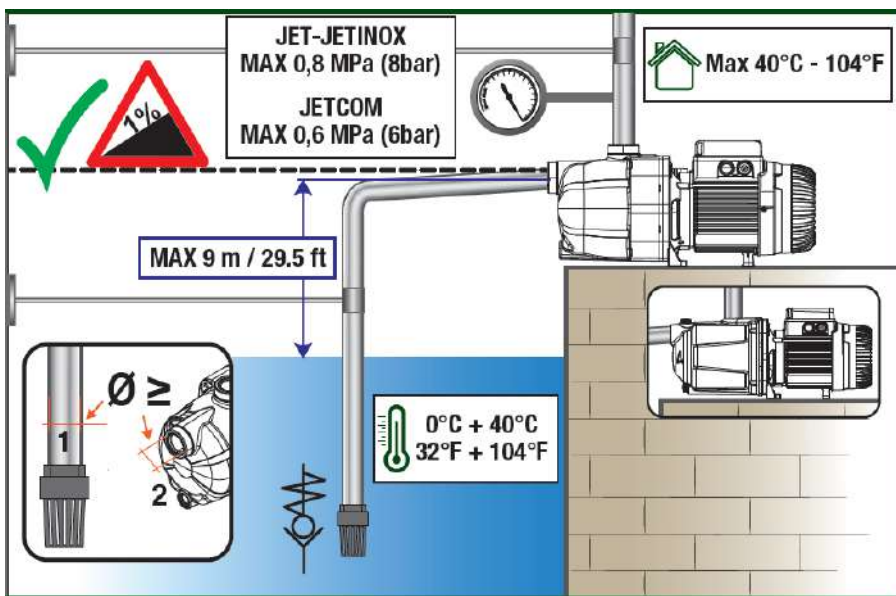

14. Water supply below the pump inlet (suction lift)

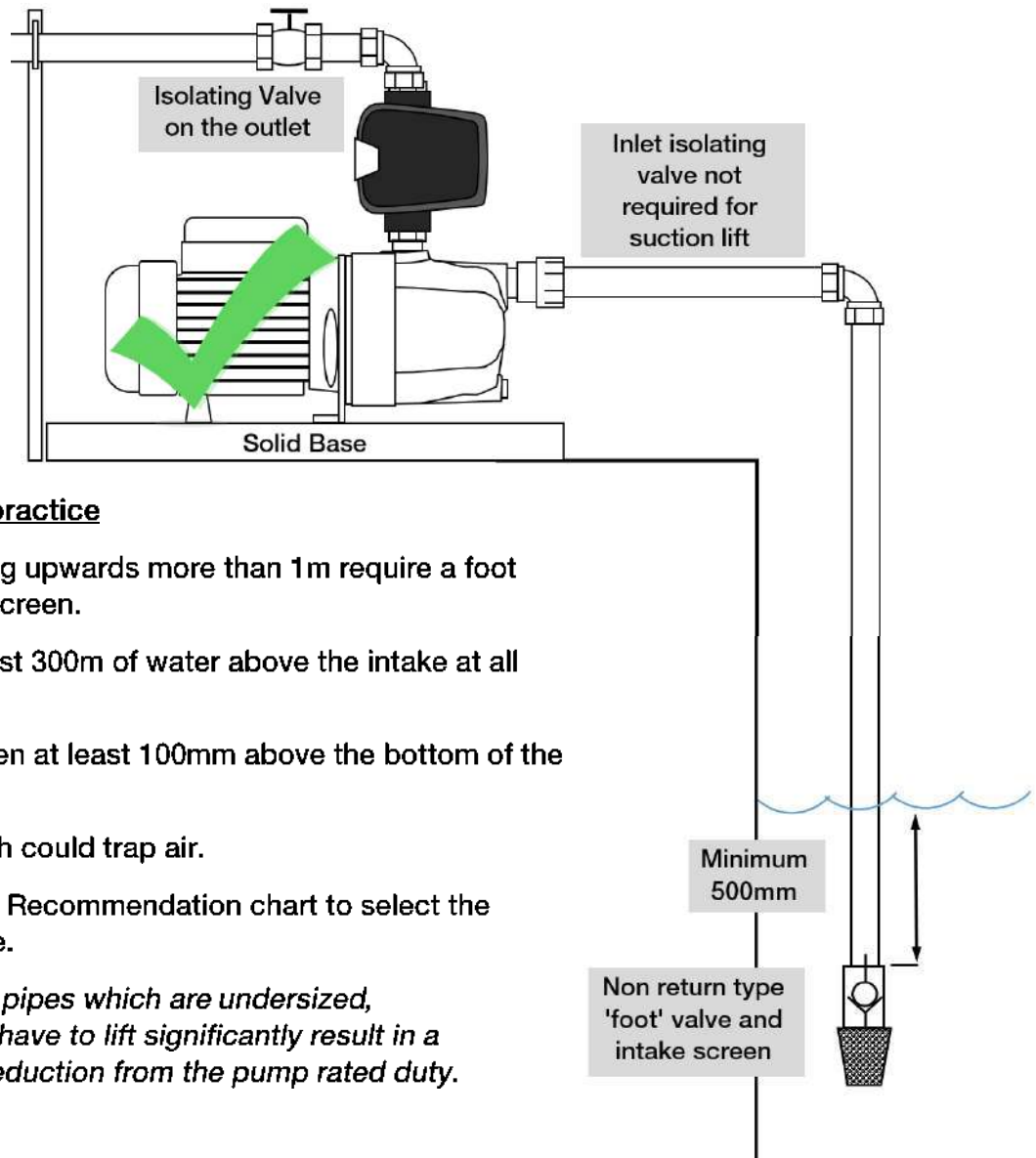

Reminders of best practice

Suction pipes drawing upwards more than 1m require a foot valve and an intake screen.

Ensure there is at least 300mm of water above the intake at all times.

Keep the intake screen at least 100mm above the bottom of the tank or well

Avoid pipework which could trap air.

Use the Suction Pipe Recommendation chart to select the correct inlet pipe size.

Intake pipes which are undersized, are long or have to lift significantly result in a substantial reduction from the pump rated duty.

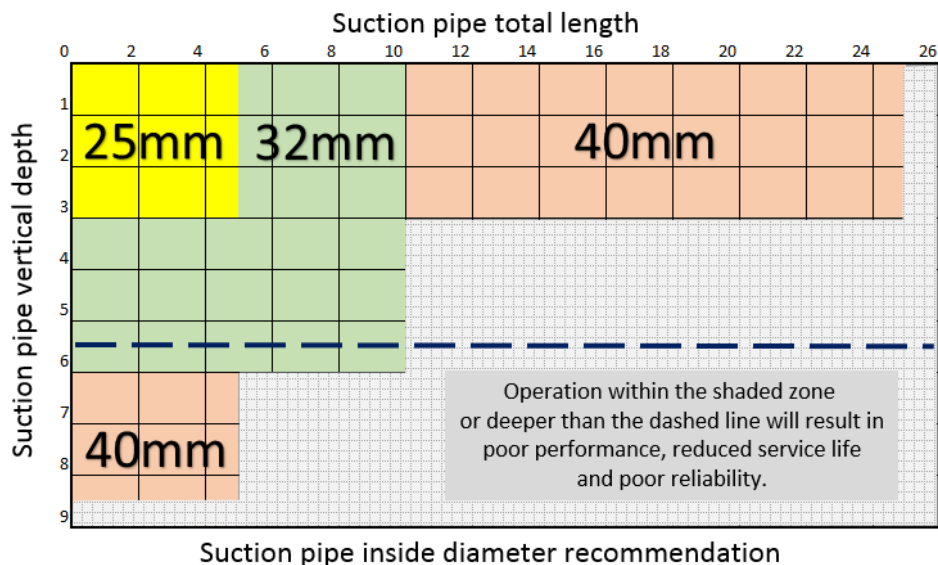

15. Priming and Operation

DAB Jet pumps “self-priming” but this still means that the pump and delivery line **MUST** be manually primed (filled) before the pump is started for the first time to ensure the mechanical seal is well lubricated. Dry operation causes irreparable damage to the mechanical seal.



Never start a pump until the pump chamber is filled with water.

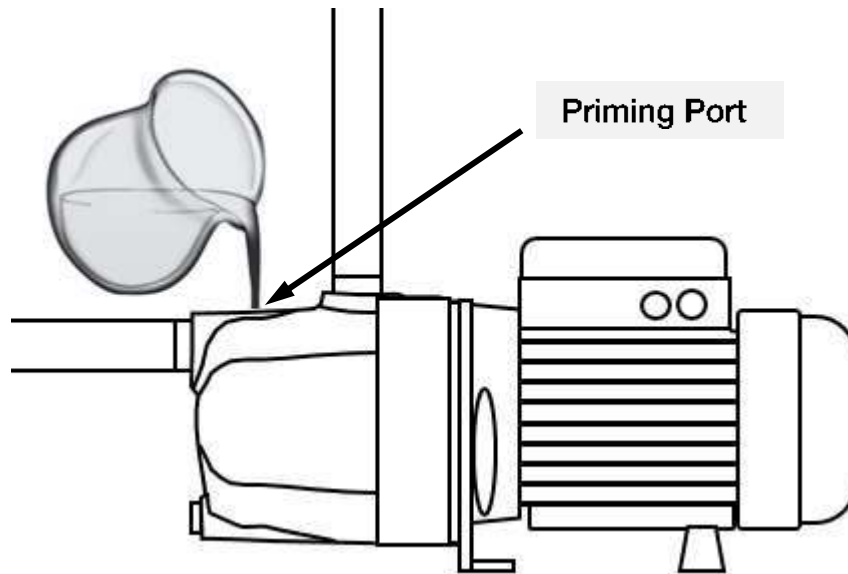

- 1 Ensure the pump power supply is disconnected.
- 2 Fill the pump body and suction line completely with clean water using the priming port.
- 3 Check that the motor fan blade rotates freely.
- 4 Ensure that the pump inlet line is fully submerged and that the pump will not draw any air into the system.
- 5 Connect to the power supply and start the pump with a tap open.

If no water comes out of the discharge or there is only limited flow, disconnect the pump from the power source and refill the pump body.

Reset the controller if it has shut down sensing ‘dry-run’ (Consult your controller manual)

Check for any possible leaks in the pipework.

Restart the pump with a tap open.

- 6 Once primed satisfactorily, check that the pump switches off when the tap or discharge line valve is closed. Prolonged running at very low flows has the potential to damage the pump and void warranty.

16. Warranties – Terms and Conditions

This warranty is given in addition to the consumer guarantees found within the Australian Competition and Consumer Act 2010 (Cth) for goods purchased in Australia and the Consumer Guarantees Act 1993 NZ for goods purchased in New Zealand:



1) White International Pty Ltd / White International NZ Ltd (White International) warrant that all products distributed are free from defects in workmanship and materials, for their provided warranty period as indicated on the top or opposite side of this document. Subject to the conditions of the warranty, White International will repair any defective products free of charge at the premises of our authorised service agents throughout Australia and New Zealand if a defect in the product appears during the warranty period. If you believe that you have purchased a defective product and wish to make a claim under this warranty, contact us on our Sales Hotline on 1300 783 601, or send your claim to our postal address or fax line below and we will advise you as to how next to proceed. You will be required to supply a copy of your proof of purchase to make a claim under this warranty.

2) This warranty excludes transportation costs to and from White International or its appointed service agents and excludes defects due to non-compliance with installation instructions, neglect or misuse, inadequate protection against the elements, low voltage or use or operation for purposes other than those for which they were designed. For further information regarding the suitability of your intended application contact us on our Sales Hotline on 1300 783 601. If you make an invalid claim under this warranty, the original product will be sent back to you unrepai red.

3) This warranty refers only to products sold after the 1st January 2012, and is not transferable to another product type and only applies to the original owner, purchaser or end user, and is in addition to the consumer guarantees found within the Competition and Consumer Act 2010 (Cth) for goods purchased in Australia and the Consumer Guarantees Act 1993 (NZ) for goods purchased in New Zealand.

4) Our goods come with guarantees that cannot be excluded under the Australian Consumer Law. You are entitled to a replacement or refund for a major failure and for compensation for any other reasonably foreseeable loss or damage. You are also entitled to have the goods repaired or replaced if the goods fail to be of acceptable quality and the failure does not amount to a major failure. 2 YEAR WARRANTY

5) To the fullest extent permitted by law, White International excludes its liability for all other conditions or warranties which would or might otherwise be implied at law. To the fullest extent permitted by law, White International's liability under this warranty and any other conditions, guarantees or warranties at law that cannot be excluded, including those in the Competition and Consumer Act 2010 (Cth), is expressly limited to: (a) in the case of products, the replacement of the product or the supply of equivalent product, the payment of the cost of replacing the product or of acquiring an equivalent product or the repair of the product or payment of the cost of having the product repaired, is at the discretion of White International or a 3rd party tribunal elected under the Competition and Consumer Act 2010 (Cth) for goods purchased in Australia and the Consumer Guarantees Act 1993 (NZ) for goods purchased in New Zealand; and

6) To the fullest extent permitted by law, this warranty supersedes all other warranties attached to the product or its packaging.

7) In the case of services, supplying the services again or the payment of the cost of having the services supplied again, is at the discretion of White International or a 3rd party tribunal elected under the Competition and Consumer Act 2010 (Cth) for goods purchased in Australia and the Consumer Guarantees Act 1993 (NZ) for goods purchased in New Zealand. 8) Our warranty commences from the date of purchase of the above mentioned pumps. Proof of purchase is required before consideration under warranty is given.

Record your date of purchase in the space below and retain this copy for your records.

Date of Purchase **Model Purchased**

17. Trouble Shooting Guide

	POSSIBLE CAUSE	POTENTIAL SOLUTIONS
The pump won't start and makes no noise	<ol style="list-style-type: none"> 1. No electricity 2. Fuses or RCD tripped 3. Internal motor fault 4. The static head pressure is greater than the cut in setting (applies when commissioning) 5. Controller has sensed dry run and is its auto restart cycle (Failure light slowly flashing) 	<ol style="list-style-type: none"> 1. Check the power supply <i>Is the power LED on the controller illuminated?</i> 2. Fuses or RCD tripped may indicate more serious problems 3. Contact an expert to check the motor 4. Static water head above the controller must be less than 20m 5. Press the controller reset button
The pump doesn't start but makes a noise	<ol style="list-style-type: none"> 1. Motor not free to turn i.e. Internal jamming 2. Faulty Capacitor 	<ol style="list-style-type: none"> 1. Check whether pump can rotate freely 2. Contact an expert to check/replace capacitor
The pump runs but there is no flow or only poor flow	<ol style="list-style-type: none"> 1. Valves closed 2. Air entering suction line (loss of prime) 3. The water level may be too low 4. Pump may be worn or damaged 5. Blockages in the pump, suction or discharge 6. In-line filters blocked (if fitted) 7. The piping may be too long or too small 	<ol style="list-style-type: none"> 1. Check suction and discharge isolating valves 2. Check for leaks and ensure all joins or fittings are sealed 3. Check water availability 4. Contact your service agent for repair 5. Contact your service agent for repair 6. Clean any filters/strainers in the system 7. Contact your pump professional
The pump runs. There is flow but poor pressure	<ol style="list-style-type: none"> 1. Excessive flow demand 2. Total head requirement too great for the pump 3. Pump may be worn or damaged 4. Air entering suction line reducing performance 	<ol style="list-style-type: none"> 1. Check that the pump selected is correct for the application 2. Check the pump specification 3. Contact your service agent 4. Ensure the suction line is sealed correctly
Pump cycling on and off	<ol style="list-style-type: none"> 1. Small water draw off or leak 2. Leak in suction or discharge line 3. Contamination in the controller 	<ol style="list-style-type: none"> 1. Check for small leaks i.e. taps or cistern 2. Check for leaks including suction line non return valve 3. Contact your service agent to inspect
Pump runs intermittently	<ol style="list-style-type: none"> 1. Overheating and thermal protection tripping 	<ol style="list-style-type: none"> 1. Ensure the water temp is less than 40 deg C Ensure sufficient airflow to cool the motor <i>Note that low voltage can cause the motor to overheat</i>
Pump vibrates and is noisy	<ol style="list-style-type: none"> 1. Incorrectly mounted/fixed 2. Internal blockage causing impeller imbalance 3. If the flow requirement is greater than the pump is capable of it will cavitate. <i>Cavitation sounds like gravel inside the pump</i> 	<ol style="list-style-type: none"> 1. Ensure the pump is solidly attached to a base 2. Contact your service agent 3. Reduce the water demand to see if the noise disappears. Ensure the suction pipe is sized correctly A different pump model may be required Contact your service agent
Water leaking from the centre of the pump	<ol style="list-style-type: none"> 1. The mechanical seal is leaking 	<ol style="list-style-type: none"> 1. Contact your service agent for repair
	POSSIBLE CAUSE	POTENTIAL SOLUTIONS



www.whiteint.com.au

www.whiteint.co.nz

Please always refer to our website for further technical information & new product innovations

Disclaimer: Every effort has been made to publish the correct information in this manual.

No responsibility will be taken for errors, omissions or changes in product specifications.

© 2020 Copyright White International Pty Ltd

TM ® - WARNING: Please be aware that various brands & products depicted within this document are subject to trademark, patent or design registrations. Infringement of any intellectual property contained within this document without express written authority by the appropriate intellectual property holder may result in further legal action to be taken. For any queries regarding use of the contained information please feel free to contact White International Pty Ltd.